

RACCORDI IN PVC RIGIDO PER CONDOTTE INTERRATE DI SCARICHI CIVILI ED INDUSTRIALI

Conformi alla norma europea UNI EN 1401

COMPLETI DI GUARNIZIONE ELASTOMERICA - COLORE ROSSO MATTONE (RAL 8023)

	ESTERNOmm	110	125	160	200	250	315	400	500	630	710	800
	CURVA A 11°	-	-	-	-	47,60	89,60	156,00	355,00	835,00	2145,00	2584,00
	CURVA A 15°	2,86	4,21	5,95	12,14	39,20	63,80	156,00	355,00	835,00	2145,00	2584,00
	Imballo	60/480	40/320	60/240	30/120	-	-	-	-	-	-	-
	CURVA A 22°	-	-	-	-	47,60	89,60	156,00	355,00	835,00	2145,00	2584,00

	ESTERNOmm	110	125	160	200	250	315	400	500	630	710	800
		2,94	4,21	7,60	15,95	39,20	71,80	156,00	355,00	835,00	2145,00	2584,00
	Imballo	55/440	35/280	17/136	24/120	-	-	-	-	-	-	-

	ESTERNOmm	110	125	160	200	250	315	400	500	630	710	800
		3,20	5,23	8,60	12,98	35,95	57,65	169,00	392,00	924,00	2145,00	2584,00
	Imballo	50/400	30/240	40/200	28/112	9/45	6/30	3/12	1	1	-	-

	ESTERNOmm	110	125	160	200	250	315	400	500	630	710	800
		3,60	5,56	9,20	16,10	56,10	89,60	198,00	532,00	1092,00	2694,00	3024,00
	Imballo	40/320	30/240	12/96	20/100	-	-	-	-	-	-	-

	ESTERNOmm	110	125	160	200	250	315	400	500	630	710	800
		4,25	6,73	10,06	20,40	44,87	73,45	198,00	532,00	1092,00	2694,00	3024,00
	Imballo	40/320	25/200	32/160	20/80	8/40	4/20	2/8	1	1	-	-

	ESTERNOmm	110	125	160	200	250	315	400	500	630	710	800
		5,60	10,20	13,65	24,93	66,00	129,70	330,00	550,00	1100,00	-	-
	Imballo	25/200	16/128	19/95	13/52	6/30	2/10	1	1	1	-	-

	ESTERNOmm	110	125	160	200	250	315	400	500	630	710	800
		6,98	9,21	17,80	30,30	66,00	159,20	420,00	728,00	1250,00	-	-
	Imballo	20/160	12/96	16/80	10/40	3/15	2/10	1	1	1	-	-

RACCORDI IN PVC RIGIDO PER CONDOTTE INTERRATE DI SCARICHI CIVILI ED INDUSTRIALI

Conformi alla norma europea UNI EN 1401

COMPLETI DI GUARNIZIONE ELASTOMERICA - COLORE ROSSO MATTONE (RAL 8023)

ESTERNOmm	110	125	160	200	250	315	400	500	630	710	800
		a:	a:	a:	a:	a:	a:	a:	a:	a:	a:
 BRAGA ridotta T 87°		110=11,20	110=12,20	110=20,33	110=36,90	110=64,90	110=212,00	110=610,00	125=1000,00		
	<i>Imballo</i>	20/160	34/170	20/80	11/55	5/25	1	1	1		
<i>Imballo</i>			125=12,20	125=22,85	125=52,90	125=69,30	125=220,00	125=610,00	160=1000,00		
			29/116	18/72	10/40	5/25	1	1	1		
<i>Imballo</i>				160=27,00	160=43,30	160=71,40	160=232,00	160=610,00	200=1000,00		
				16/64	9/36	5/25	1	1	1		
<i>Imballo</i>					200=56,20	200=98,60	200=244,00	200=610,00	250=1000,00		
					8/32	5/20	1	1	1		
<i>Imballo</i>						250=108,70	250=262,00	250=610,00	315=1000,00		
						4/16	1	1	1		
<i>Imballo</i>							315=331,00	315=610,00	400=1000,00		
								400=610,00	500=1000,00		

ESTERNOmm	110	125	160	200	250	315	400	500	630	710	800
		a:	a:	a:	a:	a:	a:	a:	a:	a:	a:
 BRAGA ridotta V 45°		110=9,70	110=11,90	110=22,50	110=39,00	110=65,00	110=260,00	110=610,00	125=1000,00		
	<i>Imballo</i>	16/128	20/100	15/75	6/30	4/20	1	1	1		
<i>Imballo</i>			125=13,20	125=24,54	125=57,00	125=69,20	125=270,00	125=610,00	160=1000,00		
			20/100	15/60	6/30	4/20	1	1	1		
<i>Imballo</i>				160=24,85	160=60,30	160=75,00	160=290,00	160=610,00	200=1000,00		
				13/52	6/30	4/20	1	1	1		
<i>Imballo</i>					200=67,60	200=98,00	200=300,00	200=610,00	250=1000,00		
					5/20	4/16	1	1	1		
<i>Imballo</i>						250=120,00	250=345,00	250=610,00	315=1000,00		
						2/10	1	1	1		
<i>Imballo</i>							315=345,00	315=610,00	400=1000,00		
								400=610,00	500=1000,00		

ESTERNOmm	110	125	160	200	250	315	400	500	630	710	800
	 TAPPO DI CHIUSURA MASCHIO	1,70	2,80	5,70	7,70	25,50	42,30	85,80	195,80	290,00	
<i>Imballo</i>		-	-	45/540	25/300	51/255	32/128	18/72	1	1	

ESTERNOmm	110	125	160	200	250	315	400	500	630	710	800
	 TAPPI DI CHIUSURA Fermina	2,70	4,20	6,70	14,20	31,50	50,00	81,40	244,00	360,00	
<i>Imballo</i>											

RACCORDI IN PVC RIGIDO PER CONDOTTE INTERRATE DI SCARICHI CIVILI ED INDUSTRIALI

Conformi alla norma europea UNI EN 1401

COMPLETI DI GUARNIZIONE ELASTOMERICA - COLORE ROSSO MATTONE (RAL 8023)

 BIGIUNTO	ESTERNOmm	110	125	160	200	250	315	400	500	630	710	800
		2,80	3,80	7,10	12,20	34,50	58,10	102,30	227,00	555,00		
	<i>Imballo</i>	70/560	55/440	60/300	33/165	12/60	7/35	7/28	1	1		

 AUMENTI Bicchiere sul diametro minore	ESTERNOmm	110	125	160	200	250	315	400	500	630	710	800
		a:	a:	a:	a:	a:	a:	a:	a:	a:	a:	a:
		110=3,25	110=4,83	110=11,30	110=36,00	110=54,00	110=108,00	110=238,00	500=446,00			
	<i>Imballo</i>	56/448	136/544	44/220	1	1	1	1	1			
			125=6,11	125=11,30	125=36,00	125=54,00	125=108,00	125=238,00				
	<i>Imballo</i>		140/700	20/160	1	1	1	1				
				160=9,80	160=36,00	160=54,00	160=108,00	160=238,00				
	<i>Imballo</i>			42/210	1	1	1	1				
					200=37,20	200=54,00	200=108,00	200=238,00				
	<i>Imballo</i>				26/130	1	1	1				
						250=44,00	250=108,00	250=238,00				
	<i>Imballo</i>					16/64	1	1				
							315=94,80	315=238,00				
								400=238,00				

 RIDUZIONI SALDATE Bicchiere sul diametro maggiore	ESTERNOmm	110	125	160	200	250	315	400	500	630	710	800
		-	-	-	-	44,00	76,00	184,00	456,00	-	-	-

 ISPEZIONE LINEARE°	ESTERNOmm	110	125	160	200	250	315	400	500	630	710	800
		12,80	17,50	28,50	38,90	86,50	108,00	230,00	308,00	520,00		
	<i>Imballo</i>	30/240	20/160	24/120	17/68	9/36	5/20	2/8	1	1		

RACCORDI IN PVC RIGIDO PER CONDOTTE INTERRATE DI SCARICHI CIVILI ED INDUSTRIALI

Conformi alla norma europea UNI EN 1401

COMPLETI DI GUARNIZIONE ELASTOMERICA - COLORE ROSSO MATTONE (RAL 8023)

ESTERNOmm  SIFONE FIRENZE 1 TAPPO	110	125	160	200	250	315	400	500	630	710	800
	27,30	34,20	45,00	77,00	238,00	436,00	960,00	2020,00			

ESTERNOmm  SIFONE FIRENZE 2 TAPPI	110	125	160	200	250	315	400	500	630	710	800
	32,90	39,50	51,00	85,20	274,00	508,00	1056,00	2100,00			

ESTERNOmm  SIFONE STAMPATO Tipo A N	110	125	160	200	250	315	400	500	630	710	800
	46,20	47,60	86,30	155,00	-	-	-	-			

ESTERNOmm  BRAGA DOPPIA e BRAGA DOPPIA RIDOTTA 45° e 87°	110	125	160	200	250	315	400	500	630	710	800
	24,50	32,50	42,50	75,00	195,00	303,00	433,00				

ESTERNOmm  INNESTI A SELLA 45° E 87°	160	200	250	315 A (110/200)	315 A 250	400 A (110/250)	400 A (315)	500 A (110/315)	500 A (400)	630 A (110/400)	630 A (500)
	16,30	25,20	46,20	65,00	78,00	118,40	155,40	181,30	192,40	240,00	292,00

RACCORDI IN PVC RIGIDO PER CONDOTTE INTERRATE DI SCARICHI CIVILI ED INDUSTRIALI

Conformi alla norma europea UNI EN 1401

COMPLETI DI GUARNIZIONE ELASTOMERICA - COLORE ROSSO MATTONE (RAL 8023)

 <p>ESTERNOmm</p> <p>DERIVAZIONE SEMPLICE 45° CON 1 TAPPO DX o SX o DORSO</p>	110	125	160	200	250	315	400	500	630	710	800
	23,00	25,70	37,70	61,10	93,00	185,00	372,00	755,00	1460,00		

ESTERNOmm

 <p>DERIVAZIONE SEMPLICE 87° CON 1 TAPPO DX O SX o DORSO</p>	110	125	160	200	250	315	400	500	630	710	800
	23,00	25,70	37,70	61,10	93,00	185,00	372,00	755,00	1460,00		

 <p>ESTERNOmm</p> <p>CURVA 45° CON 1 TAPPO DX O SX O DORSO</p>	110	125	160	200	250	315	400	500	630	710	800
	19,40	21,40	26,50	38,50	63,30	85,00	235,00	620,00	1200,00		

 <p>ESTERNOmm</p> <p>CURVA 87° CON 1 TAPPO DX O SX O DORSO</p>	110	125	160	200	250	315	400	500	630	710	800
	19,80	23,00	29,50	43,40	72,00	94,00	240,00	624,00	1215,00		

 <p>ESTERNOmm</p> <p>CLAP VALV.</p>	110	125	160	200	250	315	400	500	630	710	800
	43,30	47,50	57,00	80,95	123,70	171,20	285,36	-	-		

RACCORDI IN PVC RIGIDO PER CONDOTTE INTERRATE DI SCARICHI CIVILI ED INDUSTRIALI

Conformi alla norma europea UNI EN 1401

COMPLETI DI GUARNIZIONE ELASTOMERICA - COLORE ROSSO MATTONE (RAL 8023)

Collegamento GRES/PVC

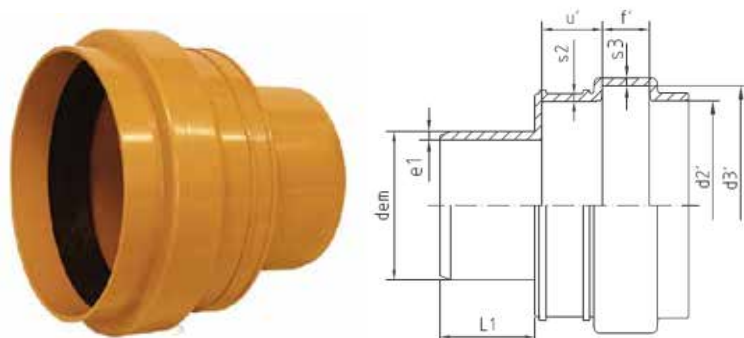



D	d2	d3	L1	L	
110	138	156,1	60	151	€ 11,80
125	163	186,1	67	172	€ 18,70
160	193	216,3	81	207	€ 23,30
200	249	278,2	99	248	€ 51,00

ESTERNOmm  FLOOD GATE	110	125	160	200	250	315	400	500	630	710	800
	46,20	58,00	64,20	109,00	193,00	273,00	416,00	445,00			

ESTERNOmm  VALVOLA A CLAPET FLANGIATA	110	125	160	200	250	315	400	500	630	710	800
	204,00	212,50	246,50	280,50	425,00	561,00	969,00	1572,00	2805,00		

ESTERNOmm  GUARNIZIONI A LABBRO	110	125	160	200	250	315	400	500	630	710	800
	0,36	0,60	0,75	1,20	2,70	3,96	6,90	12,00	24,00	63,00	75,00

ESTERNOmm  GUARNIZIONI CON ANELLO DI RINFORZO IN POLIPROPILENE TIPO SK	110	125	160	200	250	315	400	500	630	710	800
	0,54	0,84	1,08	1,74	5,10	7,50	14,64	45,90	72,00		

ESTERNOmm  GUARNIZIONI CON ANELLO DI RINFORZO IN POLIPROPILENE TIPO HBFIX	110	125	160	200	250	315	400	500	630	710	800
	0,70	1,05	1,52	2,40	6,00	9,66	16,50	53,90			