



## RACCORDI IN PVC RIGIDO PER CONDOTTE INTERRATE DI SCARICHI CIVILI ED INDUSTRIALI

Conformi alla norma europea UNI EN 1401

COMPLETI DI GUARNIZIONE ELASTOMERICA - COLORE ROSSO MATTONI (RAL 8023)

	ESTERNOmm	110	125	160	200	250	315	400	500	630	710	800
	<b>CURVA A 11°</b>	-	-	-	-	47,60	89,60	156,00	355,00	835,00	2145,00	2584,00
	<b>CURVA A 15°</b>	2,86	4,21	5,95	12,14	39,20	63,80	156,00	355,00	835,00	2145,00	2584,00
	<b>Imballo</b>	60/480	40/320	60/240	30/120	-	-	-	-	-	-	-
	<b>CURVA A 22°</b>	-	-	-	-	47,60	89,60	156,00	355,00	835,00	2145,00	2584,00

	ESTERNOmm	110	125	160	200	250	315	400	500	630	710	800
		2,94	4,21	7,60	15,95	39,20	71,80	156,00	355,00	835,00	2145,00	2584,00
	<b>Imballo</b>	55/440	35/280	17/136	24/120	-	-	-	-	-	-	-
	<b>CURVA A 30°</b>											

	ESTERNOmm	110	125	160	200	250	315	400	500	630	710	800
		3,20	5,23	8,60	12,98	35,95	57,65	169,00	392,00	924,00	2145,00	2584,00
	<b>Imballo</b>	50/400	30/240	40/200	28/112	9/45	6/30	3/12	1	1	-	-
	<b>CURVA A 45°</b>											

	ESTERNOmm	110	125	160	200	250	315	400	500	630	710	800
		3,60	5,56	9,20	16,10	56,10	89,60	198,00	532,00	1092,00	2694,00	3024,00
	<b>Imballo</b>	40/320	30/240	12/96	20/100	-	-	-	-	-	-	-
	<b>CURVA A 67°</b>											

	ESTERNOmm	110	125	160	200	250	315	400	500	630	710	800
		4,25	6,73	10,06	20,40	44,87	73,45	198,00	532,00	1092,00	2694,00	3024,00
	<b>Imballo</b>	40/320	25/200	32/160	20/80	8/40	4/20	2/8	1	1	-	-
	<b>CURVA A 87°</b>											

	ESTERNOmm	110	125	160	200	250	315	400	500	630	710	800
		5,60	10,20	13,65	24,93	66,00	129,70	330,00	550,00	1100,00	-	-
	<b>Imballo</b>	25/200	16/128	19/95	13/52	6/30	2/10	1	1	1	-	-
	<b>BRAGA T A 87°</b>											

	ESTERNOmm	110	125	160	200	250	315	400	500	630	710	800
		6,98	9,21	17,80	30,30	66,00	159,20	420,00	728,00	1250,00	-	-
	<b>Imballo</b>	20/160	12/96	16/80	10/40	3/15	2/10	1	1	1	-	-
	<b>BRAGA V A 45°</b>											

**RACCORDI IN PVC RIGIDO PER CONDOTTE INTERRATE DI SCARICHI CIVILI ED INDUSTRIALI**

Conformi alla norma europea UNI EN 1401

COMPLETI DI GUARNIZIONE ELASTOMERICA - COLORE ROSSO MATTONI (RAL 8023)

ESTERNOmm	110	125	160	200	250	315	400	500	630	710	800
		a:	a:	a:	a:	a:	a:	a:	a:	a:	a:
 <b>BRAGA ridotta T 87°</b>		110=11,20	110=12,20	110=20,33	110=36,90	110=64,90	110=212,00	110=610,00	125=1000,00		
	<i>Imballo</i>	20/160	34/170	20/80	11/55	5/25	1	1	1		
<i>Imballo</i>		125=12,20	125=22,85	125=52,90	125=69,30	125=220,00	125=610,00	160=1000,00			
		29/116	18/72	10/40	5/25	1	1	1			
<i>Imballo</i>			160=27,00	160=43,30	160=71,40	160=232,00	160=610,00	200=1000,00			
			16/64	9/36	5/25	1	1	1			
<i>Imballo</i>				200=56,20	200=98,60	200=244,00	200=610,00	250=1000,00			
				8/32	5/20	1	1	1			
<i>Imballo</i>					250=108,70	250=262,00	250=610,00	315=1000,00			
					4/16	1	1	1			
<i>Imballo</i>						315=331,00	315=610,00	400=1000,00			
							400=610,00	500=1000,00			

ESTERNOmm	110	125	160	200	250	315	400	500	630	710	800
		a:	a:	a:	a:	a:	a:	a:	a:	a:	a:
 <b>BRAGA ridotta V 45°</b>		110=9,70	110=11,90	110=22,50	110=39,00	110=65,00	110=260,00	110=610,00	125=1000,00		
	<i>Imballo</i>	16/128	20/100	15/75	6/30	4/20	1	1	1		
<i>Imballo</i>			125=13,20	125=24,54	125=57,00	125=69,20	125=270,00	125=610,00	160=1000,00		
			20/100	15/60	6/30	4/20	1	1	1		
<i>Imballo</i>				160=24,85	160=60,30	160=75,00	160=290,00	160=610,00	200=1000,00		
				13/52	6/30	4/20	1	1	1		
<i>Imballo</i>					200=67,60	200=98,00	200=300,00	200=610,00	250=1000,00		
					5/20	4/16	1	1	1		
<i>Imballo</i>						250=120,00	250=345,00	250=610,00	315=1000,00		
						2/10	1	1	1		
<i>Imballo</i>							315=345,00	315=610,00	400=1000,00		
								400=610,00	500=1000,00		

ESTERNOmm	110	125	160	200	250	315	400	500	630	710	800
		1,70	2,80	5,70	7,70	25,50	42,30	85,80	195,80	290,00	
<b>TAPPO DI CHIUSURA MASCHIO</b>	-	-	45/540	25/300	51/255	32/128	18/72	1	1		
<i>Imballo</i>											

ESTERNOmm	110	125	160	200	250	315	400	500	630	710	800
		2,70	4,20	6,70	14,20	31,50	50,00	108,00	244,00	360,00	
<b>TAPPI DI CHIUSURA Fermmina</b>											
<i>Imballo</i>											

**RACCORDI IN PVC RIGIDO PER CONDOTTE INTERRATE DI SCARICHI CIVILI ED INDUSTRIALI**

Conformi alla norma europea UNI EN 1401

COMPLETI DI GUARNIZIONE ELASTOMERICA - COLORE ROSSO MATTONE (RAL 8023)

 <b>BIGIUNTO</b>	ESTERNOmm	110	125	160	200	250	315	400	500	630	710	800
		2,80	3,80	7,10	12,20	34,50	58,10	102,30	227,00	555,00		
	Imballo	70/560	55/440	60/300	33/165	12/60	7/35	7/28	1	1		

 <b>AUMENTI</b> Bicchieri sul diametro minore	ESTERNOmm	110	125	160	200	250	315	400	500	630	710	800
			a:	a:	a:	a:	a:	a:	a:	a:	a:	a:
	Imballo		110=3,25	110=4,83	110=11,30	110=36,00	110=54,00	110=108,00	110=238,00	500=446,00		
	Imballo		56/448	136/544	44/220	1	1	1	1	1		
	Imballo			125=6,11	125=11,30	125=36,00	125=54,00	125=108,00	125=238,00			
	Imballo			140/700	20/160	1	1	1	1			
	Imballo				160=9,80	160=36,00	160=54,00	160=108,00	160=238,00			
	Imballo				42/210	1	1	1	1			
	Imballo					200=37,20	200=54,00	200=108,00	200=238,00			
	Imballo					26/130	1	1	1			
	Imballo						250=44,00	250=108,00	250=238,00			
	Imballo						16/64	1	1			
	Imballo							315=94,80	315=238,00			
Imballo								400=238,00				

 <b>RIDUZIONI SALDATE</b> Bicchieri sul diametro maggiore	ESTERNOmm	110	125	160	200	250	315	400	500	630	710	800
		-	-	-	-	44,00	76,00	184,00	456,00	-	-	-
	Imballo											

 <b>ISPEZIONE LINEARE°</b>	ESTERNOmm	110	125	160	200	250	315	400	500	630	710	800
		12,80	17,50	28,50	38,90	86,50	108,00	230,00	308,00	520,00		
	Imballo	30/240	20/160	24/120	17/68	9/36	5/20	2/8	1	1		

**RACCORDI IN PVC RIGIDO PER CONDOTTE INTERRATE DI SCARICHI CIVILI ED INDUSTRIALI**

Conformi alla norma europea UNI EN 1401

COMPLETI DI GUARNIZIONE ELASTOMERICA - COLORE ROSSO MATTONI (RAL 8023)

ESTERNOmm  SIFONE FIRENZE 1 TAPPO	110	125	160	200	250	315	400	500	630	710	800
	27,30	34,20	45,00	77,00	238,00	436,00	960,00	2020,00			

ESTERNOmm  SIFONE FIRENZE 2 TAPPI	110	125	160	200	250	315	400	500	630	710	800
	32,90	39,50	51,00	85,20	274,00	508,00	1056,00	2100,00			

ESTERNOmm  SIFONE STAMPATO Tipo A N	110	125	160	200	250	315	400	500	630	710	800
	46,20	47,60	86,30	155,00	-	-	-	-			

ESTERNOmm  BRAGA DOPPIA e BRAGA DOPPIA RIDOTTA 45° e 87°	110	125	160	200	250	315	400	500	630	710	800
	24,50	32,50	42,50	75,00	195,00	303,00	433,00				

ESTERNOmm  INNESTI A SELLA 45° E 87°	160	200	250	315 A (110/200)	315 A 250	400 A (110/250)	400 A (315)	500 A (110/315)	500 A (400)	630 A (110/400)	630 A (500)
	16,30	25,20	46,20	65,00	78,00	118,40	155,40	181,30	192,40	240,00	292,00

**RACCORDI IN PVC RIGIDO PER CONDOTTE INTERRATE DI SCARICHI CIVILI ED INDUSTRIALI**

Conformi alla norma europea UNI EN 1401

COMPLETI DI GUARNIZIONE ELASTOMERICA - COLORE ROSSO MATTONE (RAL 8023)

 <p>ESTERNOmm</p> <p><b>DERIVAZIONE SEMPLICE 45° CON 1 TAPPO DX o SX o DORSO</b></p>	110	125	160	200	250	315	400	500	630	710	800
	23,00	25,70	37,70	61,10	93,00	185,00	372,00	755,00	1460,00		

ESTERNOmm

 <p><b>DERIVAZIONE SEMPLICE 87° CON 1 TAPPO DX O SX O DORSO</b></p>	110	125	160	200	250	315	400	500	630	710	800
	23,00	25,70	37,70	61,10	93,00	185,00	372,00	755,00	1460,00		

 <p>ESTERNOmm</p> <p><b>CURVA 45° CON 1 TAPPO DX O SX O DORSO</b></p>	110	125	160	200	250	315	400	500	630	710	800
	19,40	21,40	26,50	38,50	63,30	85,00	235,00	620,00	1200,00		

 <p>ESTERNOmm</p> <p><b>CURVA 87° CON 1 TAPPO DX O SX O DORSO</b></p>	110	125	160	200	250	315	400	500	630	710	800
	19,80	23,00	29,50	43,40	72,00	94,00	240,00	624,00	1215,00		

 <p>ESTERNOmm</p> <p><b>CLAP VALV.</b></p>	110	125	160	200	250	315	400	500	630	710	800
	43,30	47,50	57,00	80,95	123,70	171,20	285,36	-	-		

**RACCORDI IN PVC RIGIDO PER CONDOTTE INTERRATE DI SCARICHI CIVILI ED INDUSTRIALI**

Conformi alla norma europea UNI EN 1401

COMPLETI DI GUARNIZIONE ELASTOMERICA - COLORE ROSSO MATTONE (RAL 8023)

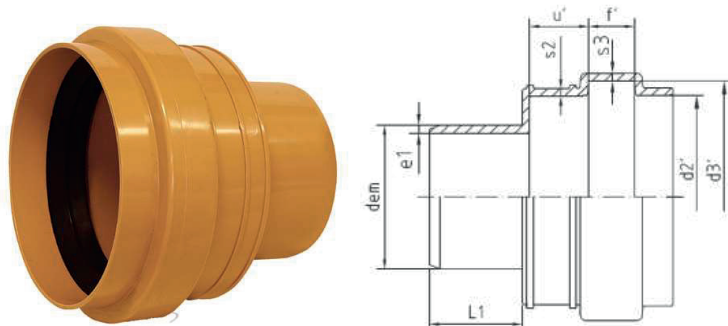
**Collegamento GRES/PVC**

D	d2	d3	L1	L	
110	138	156,1	60	151	€ 11,80
125	163	186,1	67	172	€ 18,70
160	193	216,3	81	207	€ 23,30
200	249	278,2	99	248	€ 51,00

ESTERNOmm  FLOOD GATE	110	125	160	200	250	315	400	500	630	710	800
		46,20	58,00	64,20	109,00	193,00	273,00	416,00	445,00		

ESTERNOmm  VALVOLA A CLAPET FLANGIATA	110	125	160	200	250	315	400	500	630	710	800
		204,00	212,50	246,50	280,50	425,00	561,00	969,00	1572,00	2805,00	

ESTERNOmm  GUARNIZIONI A LABBRO	110	125	160	200	250	315	400	500	630	710	800
		0,36	0,60	0,75	1,20	2,70	3,96	6,90	12,00	24,00	63,00

ESTERNOmm  GUARNIZIONI CON ANELLO DI RINFORZO IN POLIPROPILENE TIPO SK	110	125	160	200	250	315	400	500	630	710	800
		0,54	0,84	1,08	1,74	5,10	7,50	14,64	45,90	72,00	

ESTERNOmm  GUARNIZIONI CON ANELLO DI RINFORZO IN POLIPROPILENE TIPO HBFIX	110	125	160	200	250	315	400	500	630	710	800
		0,70	1,05	1,52	2,40	6,00	9,66	16,50	53,90		